



**TOYOTA  
LAND CRUISER 300**



## MORE POWER

Toyota's Land Cruiser began with the **TOYOTA JEEP BJ SERIES** in 1951 and by 2019, the global total sales volume reached 10 million units. In 2021 we celebrate the 70th anniversary of the Land Cruiser series.

The Land Cruiser is a vehicle built for every road and to suit every person's life. These vehicles are built to carry anything you need to any part of the world no matter how remote or how tough the roads.

This high level of reliability is the reason why this model has been part of so many families and businesses and will continue to be part of our lives for years to come.

# A STORY OF INHERITANCE SINCE 1951





**THE KING OF 4X4**



## CONQUER THE CITY WITH ELEGANCE AND STYLE

The resolute design is solidified by a strong grille and high gloss 20" alloy wheels that culminate in a bold and elegant presence. Take control.



## AN INTERIOR THAT IS BOTH COMFORTABLE AND CONVENIENT

**Palatial comfort and practical convenience: why choose when you can have both?**

Elegant and cosy with quality materials, the new Land Cruiser provides extra convenience thanks to its versatile seat configurations. Travel in style and luxury with up to 7 passengers and all of their luggage.



### SEATING CONFIGURATION OPTIONS

All seats can be flexibly arranged for a wide range of seating and luggage hold options.



### REAR AIR CONDITIONING

An automatic rear air conditioner helps enhance rear passenger comfort.



### LUGGAGE ROOM

A switch allows you to automatically stow the third row seats (electric control only, grade dependent) under the floor to create ample storage room.



Toyota has developed a new GA-F platform based on the Toyota New Global Architecture (TNGA). Newly developed turbocharged V6 engines include gasoline and diesel variants, both offering greatly improved power, torque and efficiency from a smaller displacement compared to the current model. A 200kg weight reduction was achieved across the entire vehicle as a result of this initiative to help in fuel efficiency.

**Engine 3.3 Diesel F33A-FTV Engine (10 speed Automatic)**

Power Max output 306 hp (225 kW) / 4000 rpm  
Torque Max torque 700 Nm / 1600-2600 rpm

**Engine 3.5 Petrol V35A-FTS Engine (10 speed Automatic)**

Power Max output 415 hp (305 kW) / 5200 rpm  
Torque Max torque 650 Nm / 2000-3600 rpm

# EXCEPTIONAL POWER

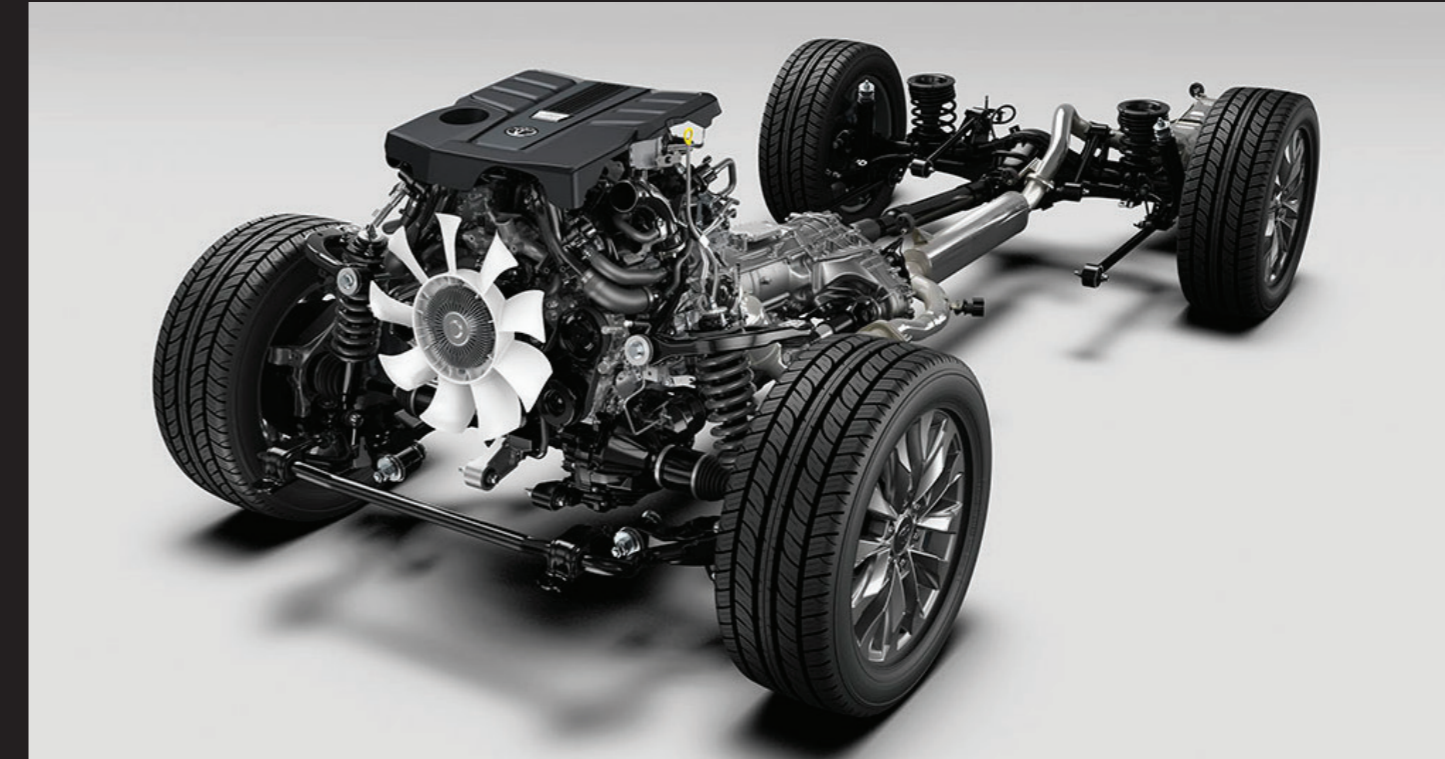

**V6 3.3 LITRE DIESEL ENGINE WITH 10 SPEED AUTOMATIC TRANSMISSION**

The new 3.3 litre Twin Turbo Diesel Engine features smarter and more efficient technology with seamless shifts between single and dual turbo use as well as increased performance.

This engine aims to enhance environmental friendliness, fuel efficiency, driving performance, durability, quietness, and ground-covering performance on rough roads. The rotating and reciprocating parts have been made suitable to enhance fuel efficiency, driving performance, durability and cabin comfort. The exhaust and turbocharging systems too, have been revised to enhance smooth acceleration, driving performance, durability, and environmental friendliness.

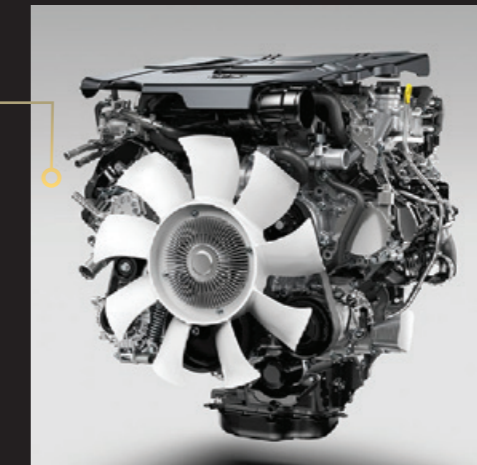

**NEW 10-SPEED TRANSMISSION**

Newly developed AJAOF 10-speed automatic transmission available standard on both engines enhance driving performance, fuel efficiency, and quietness.

- A newly developed torque converter and high precision lock-up slip control achieve excellent fuel efficiency and smooth acceleration feel matching driver's intensions.
- Cross-over gear ratios, component optimization, and precise high-response control achieve an excellent shifting feel and exhilarating rhythmic gear shift feel.
- The structure and control of the transmission aiming for utilizing a highly efficiency range of the engine reduce slip loss of the torque converter and enhance transmission efficiency.

# 4WD UPGRADE TO THE TOP

ADVANCED TECHNOLOGY FEATURES FOR  
EXCEPTIONAL DRIVING PERFORMANCE



## MULTI-TERRAIN SELECT WITH AUTO MODE



Multi-Terrain Select is a revolutionary system that enables you to drive over all kinds of road surfaces. When the transfer range is in H4 or in L4, the system selects respectively from five and four different modes to address the road surface and provide optimal traction.

In addition, by selecting AUTO mode, the vehicle estimates the current driving surface based on information from various sensors to optimise driving force and suspension control. The driver does not need to change the driving mode to get the best off-road performance.



## MULTI-TERRAIN MONITOR

With four cameras installed on the front, sides and rear of the vehicle, the system provides off-road driving support by capturing the road conditions around the vehicle, which are often in the driver's blind spots.



The center display shows the front, rear, left and right of the vehicle, as well as an image featuring guidelines of the view directly underneath the vehicle as if the floor were transparent. In addition, a panoramic view will display an image of the vehicle from above.

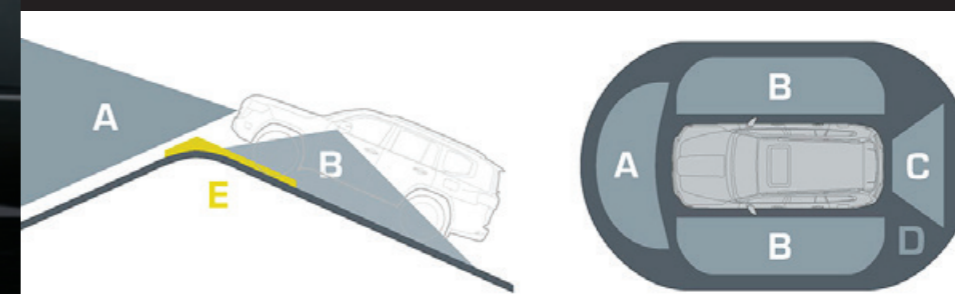
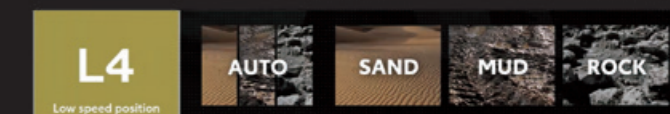
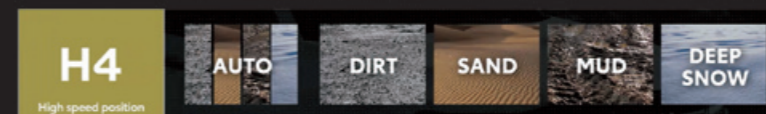

- A Front view
- B Side view (left & right)
- C Back view
- D Panoramic view
- E Underfloor view



# FEEL THE POWER

## ELECTRONIC KINETIC DYNAMIC SUSPENSION SYSTEM

The newly developed E-KDSS detects road surface conditions, vehicle speed, and steering operation. It automatically and independently locks or frees the front and rear stabilizers. The system performs detailed control according to the detected cornering and road surface conditions. Thus, it enhances off-road driving performance, ride comfort as well as on-road handling stability.

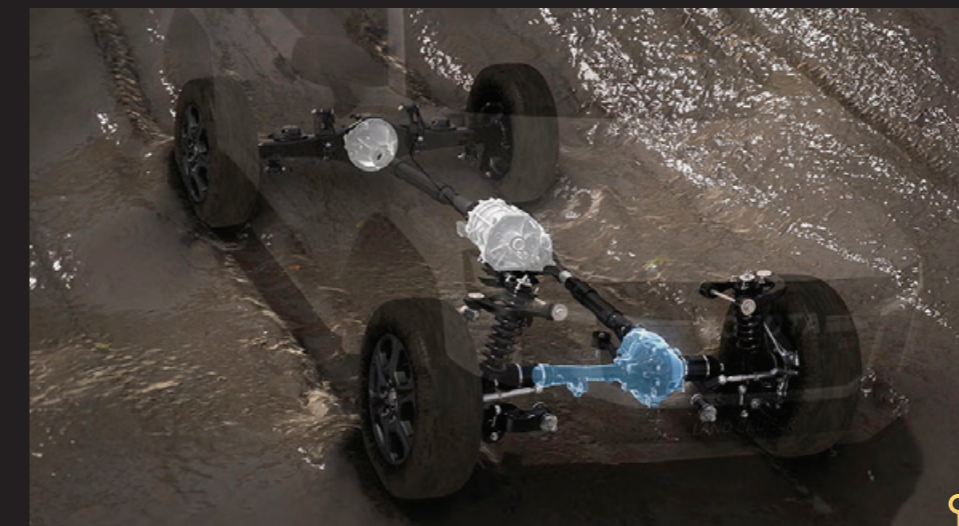

## FRONT DIFFERENTIAL LOCK

In addition to the rear differential lock, there is a new front differential lock. Even on rough roads, when one wheel is lifted off the ground, the system distributes driving force optimally to the grounded tire. This improves escape performance and provides excellent rough-road driving performance.



## AVS: ADAPTIVE VARIABLE SUSPENSION

Adaptive Variable Suspension System with linear solenoid type enhances ride comfort and driving performance on rough roads. The system adjust damping force according to road conditions from small irregularities to large bumps and dips. Thus, it contributes to enhancing ride comfort, handling stability and ground covering performance on rough roads.



## CRAWL CONTROL

Crawl Control helps provide optimal throttle and brake control maintaining a constant low speed. It supports a safe and sure driving on sand, dirt, rock, snow, mud, steep grades, or other surfaces that require fine accelerator control. Five speeds are offered with fully automatic throttle and brake control. It helps you concentrate on steering the vehicle.



## TURN ASSIST FUNCTION

Turn Assist helps to turn the vehicle in response to the driver's steering, while maintaining a consistently low speed, even in tight corners, which would normally be difficult to pass without a turnaround maneuver.





40 NATURAL BEIGE

Connect your smartphone thanks to Apple CarPlay or AndroidAuto on the 12,3" screen to take the road safely while enjoying your own music with 14 JBL speakers.

**PROGRESSION OF LUXURY**



30/31 BLACK & DARK RED



20/21 BLACK



# ADVANCED SAFETY TECHNOLOGIES

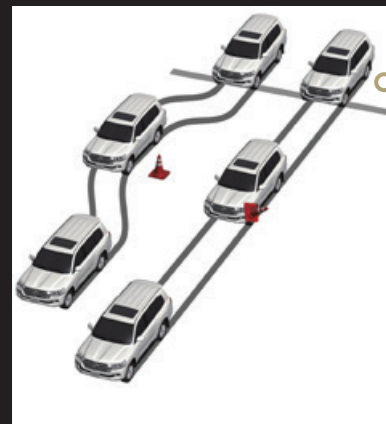

## ABS: ANTI-LOCK BRAKE SYSTEM

ABS operates by preventing the wheels from locking up during intensive braking. It thereby maintains tractive contact with the road surface. Thus, it allows the driver to maintain more control over the vehicle.

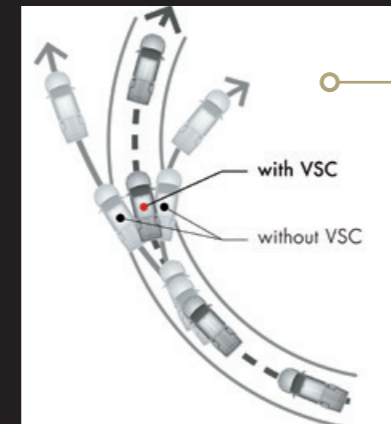

## VSC: VEHICLE STABILITY CONTROL

It automatically activates each individual brake as needed and controls engine output to help maintain stability. It also prevents skidding when turning sharply or cornering on slippery road surfaces.

# MORE SAFETY FEATURES

## AIRBAGS (SRS)

Front and knee airbags for the driver and front-seat passenger, side airbags for first and second rows, and curtain-shield airbags for all three rows support passenger safely in the event of a collision.

\*Availability of airbags differs depending on vehicle specifications.

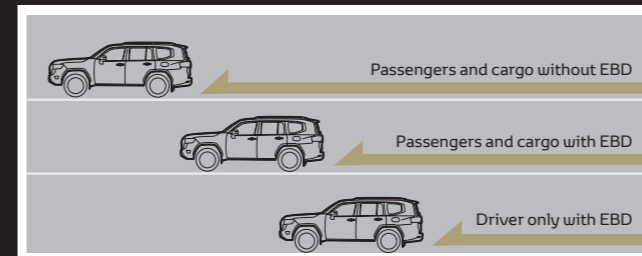

## EBD: ELECTRONIC BRAKE FORCE DISTRIBUTION

Even when there is a difference in front/rear or left/right wheel load, EBD controls brake force on each wheel appropriately and helps to shorten stopping distance. The EBD controls the braking force on the wheels, based on the total number of the occupants, load conditions and during deceleration and cornering. Thus, it offers excellent brake control.

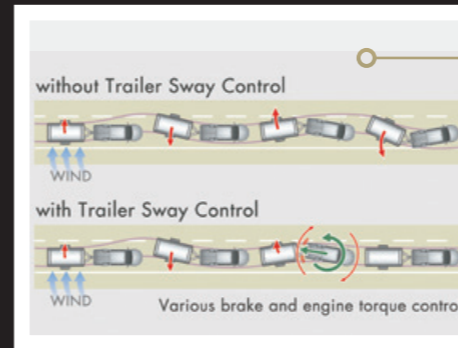

## TSC: TRAILER SWAY CONTROL

It suppresses any trailer sway caused by wind, bumpy roads or steering whenever you are towing. With sensors detecting yaw, acceleration and steering, TSC uses deceleration control and yaw moment to limit sway. The stop lamps are illuminated to warn drivers behind.

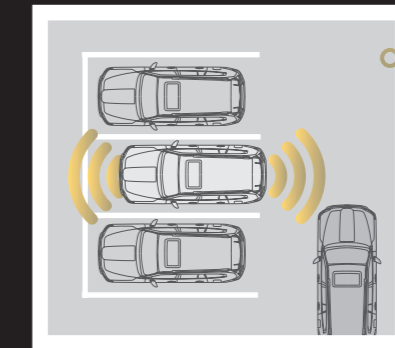

## PARKING SUPPORT SYSTEMS

Parking support brake system provides driving force suppression and brake control for situations when there is a risk of collision. Whether it is with obstacles in front or behind the vehicle or when driving at low speeds, such as when parking, it activates.

# GRADES AND COLORS



VX-R GRADE

VX grade

GR-S grade



202 Black



1G3 GRAY ME



070 WHITE PEARL CS



4V8 AVANT GARDE BRONZE ME



090 PRECIOUS WHITE PEARL



040 SUPER WHITE



8X8 DARK BLUE MC



3Q3 DARK RED M.M



218 ATTITUDE BLACK MC



1F7 SILVER ME

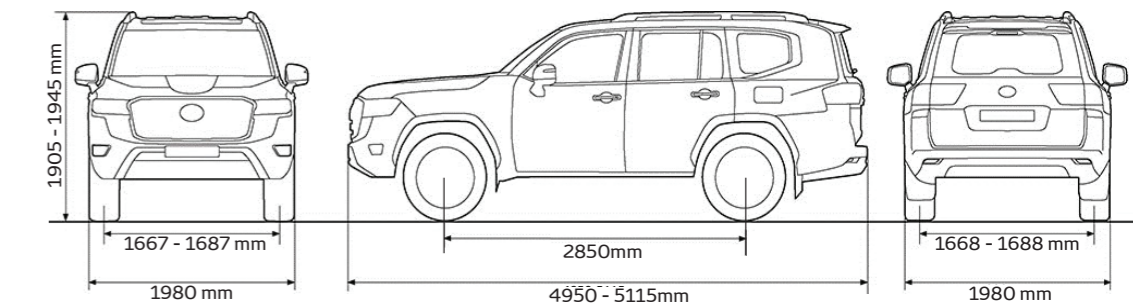

# TECHNICAL SPECIFICATIONS

Description	LC 300 GX-R Diesel	LC 300 VX Diesel	LC 300 VX-R Diesel	LC 300 GR-S Diesel	LC 300 VX Petrol	LC 300 VX-R Petrol
Model Grade	GX-R	VX	VX-R	GR-S	VX	VX-R
Model Code	FJA300L-GNUAY (D0)	FJA300L-GNUVY (D3)	FJAL-GNUZY (D6)	FJA300L-GNUSY (D9)	VJA300L-GNUVZ (P3)	VJA300L-GNUZZ (P6)
Seating Capacity	7	7	7	7	7	7
Body Type	SUV	SUV	SUV	SUV	SUV	SUV
Engine Code	F33A-FTV	F33A-FTV	F33A-FTV	F33A-FTV	V35A-FTS	V35A-FTS
Number of cylinders and arrangement	6-Cyls. V Type	6-Cyls. V Type	6-Cyls. V Type	6-Cyls. V Type	6-Cyls. V Type	6-Cyls. V Type
Engine	Displacement (cm3)	3346	3346	3346	3346	3445
	Capacity (litre)	3.3L	3.3L	3.3L	3.3L	3.5L
	Bore x Stroke (mm)	86.0 x 96.0	86.0 x 96.0	86.0 x 96.0	85.5 x 100.0	85.5 x 100.0
	Compression ratio	15,4	15,4	15,4	10,37	10,37
Maximum power (kW (HP) @ r/min)	225(306) @ 4000	225 (306) @ 4000	225 (306) @ 4000	225 (306) @ 4000	305 (415) @ 5200	305 (415) @ 5200
Maximum torque (Nm @ r/min)	700 @ 1600-2600	700 @ 1600-2600	700 @ 1600-2600	700 @ 1600-2600	650 @ 2000-3600	650 @ 2000-3600
Transmission	10AT	10AT	10AT	10AT	10AT	10AT
Gear ratio	1st	4,923	4,923	4,923	4,923	4,923
	2nd	3,257	3,257	3,257	3,257	3,257
	3rd	2,349	2,349	2,349	2,349	2,349
	4th	1,944	1,944	1,944	1,944	1,944
	5th	1,532	1,532	1,532	1,532	1,532
	6th	1,193	1,193	1,193	1,193	1,193
	7th	1,000	1,000	1,000	1,000	1,000
	8th	0,801	0,801	0,801	0,801	0,801
	9th	0,661	0,661	0,661	0,661	0,661
	10th	0,613	0,613	0,613	0,613	0,613
Reverse	4,307	4,307	4,307	4,307	4,307	4,307
Final drive gear ratio	3,307	3,307	3,307	3,307	3,307	3,307
Brakes	Front	VENTILATED DISC BRAKE WITH FIXED CALIPER 4-CYLINDER	VENTILATED DISC BRAKE WITH FIXED CALIPER 4-CYLINDER	VENTILATED DISC BRAKE WITH FIXED CALIPER 4-CYLINDER	VENTILATED DISC BRAKE WITH FIXED CALIPER 4-CYLINDER	VENTILATED DISC BRAKE WITH FIXED CALIPER 4-CYLINDER
	Rear	VENTILATED DISC BRAKE WITH FLOATING CALIPER 1-CYLINDER	VENTILATED DISC BRAKE WITH FLOATING CALIPER 1-CYLINDER	VENTILATED DISC BRAKE WITH FLOATING CALIPER 1-CYLINDER	VENTILATED DISC BRAKE WITH FLOATING CALIPER 1-CYLINDER	VENTILATED DISC BRAKE WITH FLOATING CALIPER 1-CYLINDER
<b>Dimensions and Capacities</b>						
Overall vehicle length (mm)	4950-5115	4950-5115	4950-5115	4965-5130	4950-5130	4950-5140
Overall vehicle width (mm)	1980	1980	1980	1990	1980	1980
Overall vehicle height (mm)	1905-1945	1905-1945	1905-1945	1905-1945	1905-1945	1905-1945
Wheelbase (mm)	2850	2850	2850	2850	2850	2850
Front Overhang (mm)	920	920	945	935	935	935
Rear overhang (mm)	1345	1345	1345	1345	1345	1345
Approach angle (*°)	32	32	24	32	32	24
Front Tread (mm)	1667	1667	1667	1667	1667	1667
Minimum ground clearance (mm)	235	235	235	235	235	235
Minimum turning circle (tyres, m)	5,9	5,9	5,9	5,9	5,9	5,9
Fuel Tank Size (L)	110	110	110	80	110	110
Gross vehicle weight (kg)	3230	3230	3230	3230	3230	3230
Front tread	1668	1668	1668	1668	1668	1668

GX-R - STANDARD GRADE	VX - on top of GX-R	VX-R - on top of VX	GR-S on top of VX-R
<b>Interior:</b>	<b>Interior</b>	<b>Interior</b>	
2-Zone Auto Air Conditioner Rear climate controls Air cleaner with pre-cleaner Radio AM/FM, MP3, CD, DVD Multimedia touch screen 7-inch (17.78 cm) Reverse camera (back monitor) Front and rear parking sensors Bluetooth audio and hands-free Wifi device support 6 speakers Auxiliary input USB Central cool box Wireless power door lock Power windows (all) one touch up/down and auto jampro Steering wheel controls, multi info, cruise control, audio & tele Leather steering wheel Tilt and telescopic steering adjustment Illuminated entry system Fabric seats, 7 seats, floor mats Moon roof with jam protection Electronic vertical driver seat adjust	4-Zone Auto Air Conditioner (Front and Rear) Leather feel seats Electronic vertical driver and passenger seat adjust Power tilt and telescopic steering adjustment Power back door (w/close & lock switch) Leather steering wheel with wood imitation Wireless charger for mobile phones Moon roof with jam protection and remote control	Multimedia touch screen 12.3-inch (31 cm) 14 speakers, JBL sound system with navigation system Door trim synthetic leather and with wood imitation RSE - Rear Seat Entertainment system, dual Two built-in DVD players in the back with 11.6-inch monitors Two wireless headphones for Rear Seat Entertainment Multi-Terrain monitor, 4 cameras (front, sides, back) & washer Multi-terrain select Premium leather seats Ventilated seats for driver, passenger and rear seats Seat heating for driver, passenger and 2nd row seats Power seat adjustments with memory for driver Kick sensor back door opening HDMI audio jack	GR-S push start GR-S headrests New Stability Control GR-S Leather seats (with stitching)  GR-S style alloy 18", 265/65 R18 tyre FR & RR Differential Lock Power Back Door W/Pre lock Sw (No kick sensor) GR-S Smart Key  GR-S Mud Guards GR-S Grille and Bumper GR-S Steering Wheel Carbon front console 80L Single Fuel Tank
<b>Exterior:</b>	<b>Exterior:</b>	<b>Exterior:</b>	
Colour painted front and rear bumpers Mud guards (front and rear) Side steps, aluminium Outside mirrors elect adjustable & retractable, colour Roof rails Rear spoiler Spare tire under the vehicle with lock Colour painted door handles LED Daytime Running Lights	Front fog lamps (LED) Chromed outside mirrors heated with memory Acoustic windshield glass	Side steps with illumination Mud guards full cover (only front) Illuminated scuff plates Aero bumpers with chrome details (Front and Rear) Rear fog lamps	
<b>Safety:</b>	<b>Safety:</b>	<b>Safety:</b>	
Driver & Passenger Airbags (SRS) ABS - Anti-lock Braking System EBD - Electronic Brake force Distribution BA - Brake Assist ATRC - Active Traction Control System VSC - Vehicle Stability Control TSC - Trailer Sway Control Anti-Theft system immobilizer and alarm ISOFIX points for child safety on rear outer seats	Side airbags (SRS) Curtain airbags (SRS)		
<b>Technical</b>	<b>Technical</b>	<b>Technical</b>	
LED type main headlamps (low) Smart entry & Start system (keyless entry & start) Push start system Rear differential lock Alloy wheels Tyre dimensions 265/65R18 (71/2J Alum) Cruise control Integrated sport driving mode (3 Mode) 110L fuel tank capacity (dual 80+30) Power steering wheel iLUD System Optitron gauge lightning	Welcome lightning system Bi-LED type main headlamps (low and high) DAC - Downhill Assist Control TA - Turn Assist Crawl Control AIM - AWD Integrated Management Automatic high beam control Headlamp cleaner BSM - Blind Spot Monitoring System Auto headlamp levelling, auto dynamic Auto dimming rear view mirror (day/night) iLUD System Tyre dimensions 265/65R18 (71/2J Alum) High Gloss Rain sensor, automatic wipers control	Torque Sensing LSD Tyre dimensions 265/55 R20, alloy wheels TEMS - Toyota Electronic Modulated Suspension AVS - Adaptive Variable Suspension System Integrated sport driving mode (5 Mode) MTS - Multi-Terrain Select Anti-theft with siren intusion and slat sensor Head Up Display (240 x 90 color)	



# COMPLETE PEACE OF MIND WITH TOYOTA.

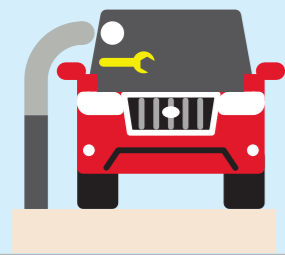

## Toyota Quality Service

Your Toyota dealership will advise you on your vehicle's service requirements. It will need a health and safety check at least once a year. An intermediate check is necessary every year or 5,000km.

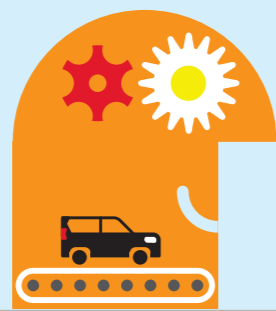

## Toyota Low Maintenance Costs

All Toyota vehicles are designed and engineered to minimize your maintenance costs. This includes fewer parts that require servicing and, equally important, is that Toyota vehicle technology is made accessible so that maintenance labor time is reduced and pricing is competitive.

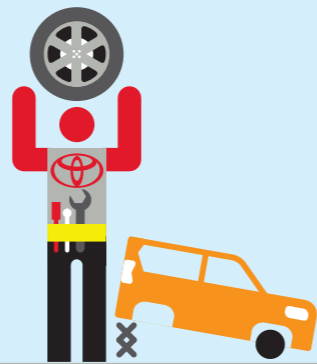

## Toyota Genuine Parts

Providing the reassurance of Toyota quality, only genuine and approved components are used on your vehicle. If the vehicle is damaged, its design helps minimize the cost of repair because the most expensive-to-replace parts are deliberately located away from common damage zones. The result is less expense for parts and labor.



## Toyota Accessories

Toyota genuine accessories are designed and manufactured with the same care, quality and attention to detail as Toyota vehicles. Adding a touch of style, comfort, convenience and practicality, they are tested for exceptional durability to enhance the enjoyment of your new vehicle. All accessories are covered by a 1-year warranty.

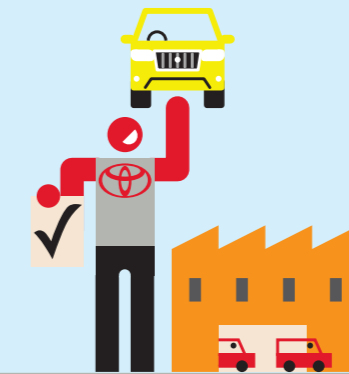

## Toyota Comprehensive Warranty

Every new Toyota comes with a 3 years or 100,000km vehicle warranty, which covers any defect caused by a manufacturing fault. Transport to the nearest authorized Toyota repairer will also be covered\*. In addition, a 3 years or 100,000km paint warranty protects against defects and surface rust caused by a manufacturing fault (except load bins which are covered for 1 year.) Every

Toyota commercial vehicle is covered by a 3 years unlimited mileage corrosion-perforation warranty\* against corrosion of body panels caused by a manufacturing fault in materials or workmanship.



## Toyota Added Security

Toyota's comprehensive security system withstands the insurance industry's rigorous five-minute attack test. The alarm system and immobilizer are approved by major insurance companies.

\*Check with your dealership for specific warranty details.



**FOR MORE INFORMATION ABOUT  
THE LAND CRUISER 300 AND QUOTATIONS,  
PLEASE CONTACT YOUR NEAREST TOYOTA DEALERSHIP.**

To the best of our knowledge, all information in this brochure is correct at time of going to print. Details of specifications and equipment provided in this brochure are subject to local conditions and requirements and may, therefore, vary from models available in your area. Please inquire with your local dealership for details on your local specifications and equipment. • Vehicle body colors may differ slightly from the printed photographs in this brochure. • The readability of QR Codes® present in this brochure may differ according to the scanner used. Toyota cannot be held responsible should your device not be able to read any QR Codes® or interactive content markers. • CFAO group reserves the right to alter any details of specifications and equipment without prior notice. • No part of this publication may in any way be reproduced without the prior written approval of CFAO group. 08/2021/LC300/CFAO

